

Controlling your cloud

A guide to OpenStack

Rodolfo Tobon
17 July 2012

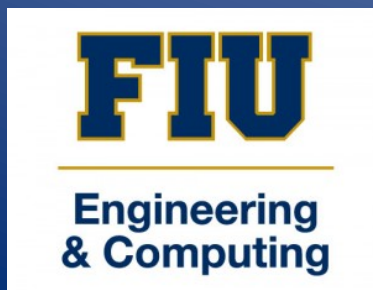

Universidade Estadual Paulista

Núcleo de Computação Científica

Adviser
Carlos Moreira
carlosm@ncc.unesp.br

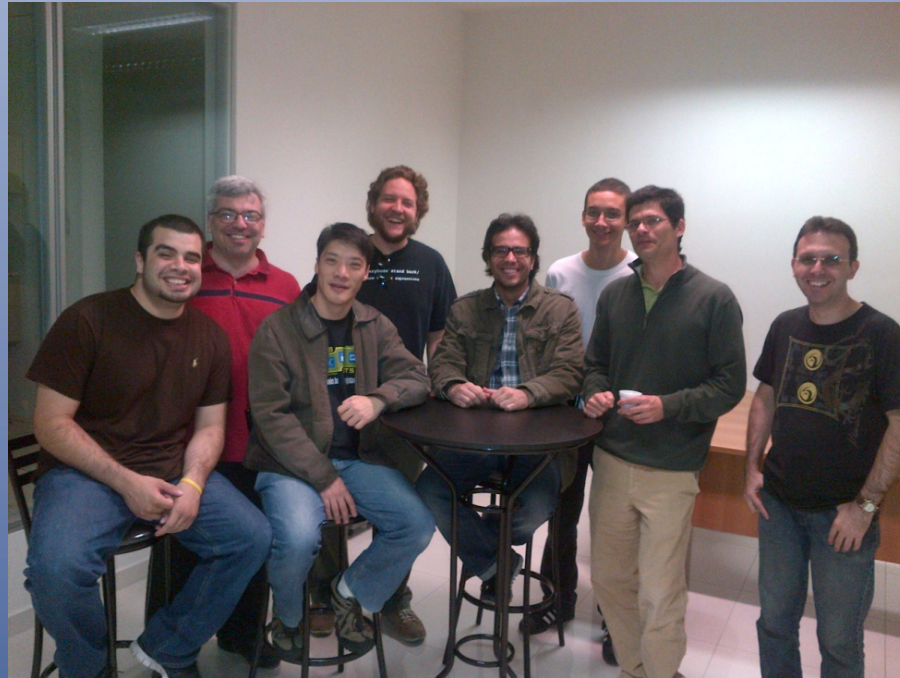

FIU

Engineering
& Computing



What is Cloud Computing?

Is the delivery of computing services to a heterogeneous community so the end user can “rent” the server



It is maintain and govern by the Cloud Engineers

FIU

Engineering
& Computing



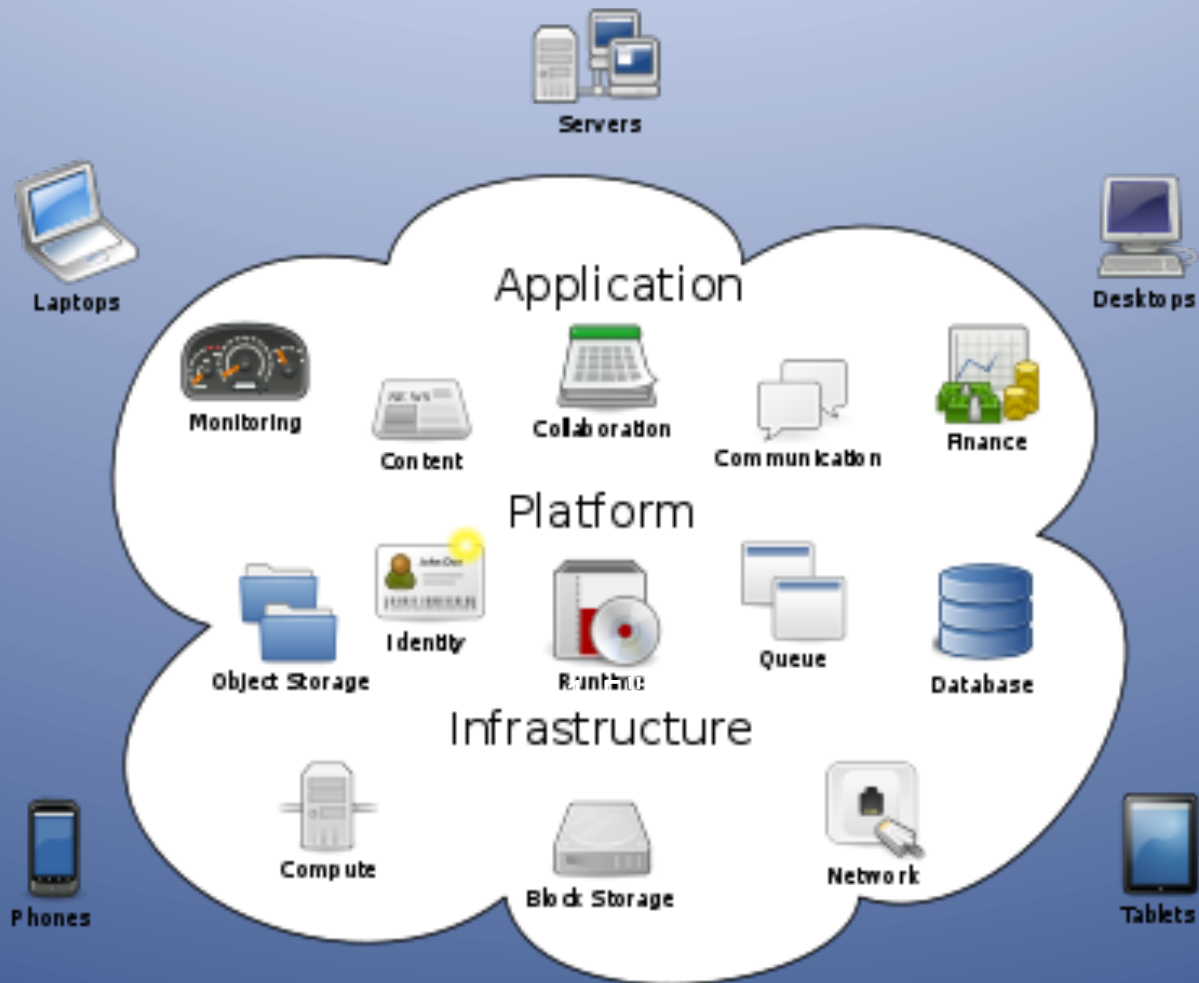

Cloud Computing



Controls large pools of computing,
storage, and networking



Newest version: Essex

Founded in 2010 by Rackspace & NASA

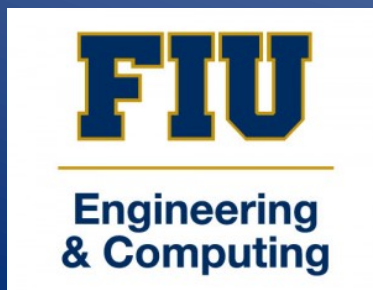

OpenStack Projects



- Nova
- Swift
- Glance

*Two new projects

- Horizon
- Keystone

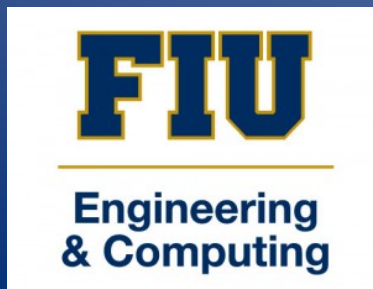

NOVA

Fabric controller for OpenStack

Startup instance

Configure the network

Provide servers on demand

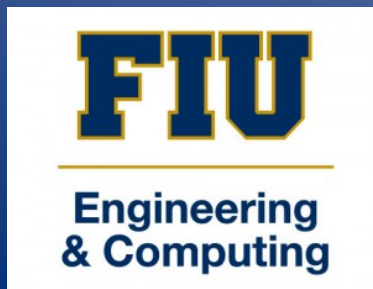

SWIFT

Allows the user to store and retrieve files, backup up, & archive data.

A system to store massively scalable data with built in redundancy & failover.

FIU

Engineering
& Computing



GLANCE

Discovery, registration and delivery for virtual disk

Provides a catalog and repository for virtual disk

FIU

Engineering
& Computing





Mobile Apps, Web Clients, Enterprise Software Ecosystem

API Layer

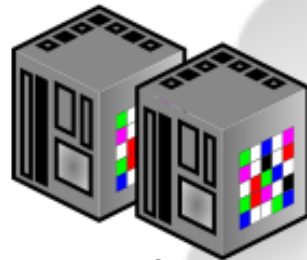

OpenStack Compute

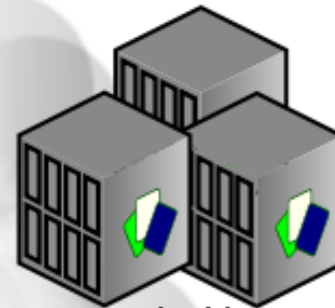

OpenStack Object Storage



OpenStack Imaging Service

FIU

Engineering
& Computing



HORIZON
is a modular
web-based user
interface for
all the
OpenStack
services.

Instances & Volumes

Logged in as: demo. Settings Sign Out

Success: Instance "test" launched.

Instances Launch Instance Terminate Instances

	Name	IP Address	Size	Status	Task	Power State	Actions
<input type="checkbox"/>	test		512MB RAM 1 VCPU 0 Disk	Build	None	No State	Edit Instance

Displaying 1 item

Volumes Create Volume Delete Volumes

Name	Description	Size	Status	Attachments	Actions
No items to display.					

Displaying 0 items



KEYSTONE

Provides Authentication and Authorization

It also provides a service catalog of services within a particular deployment

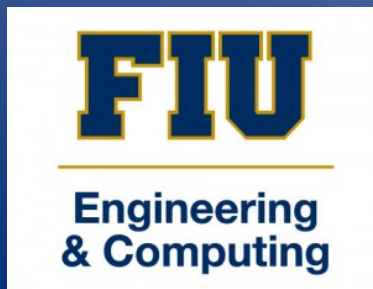

The Keystone Identity Manager

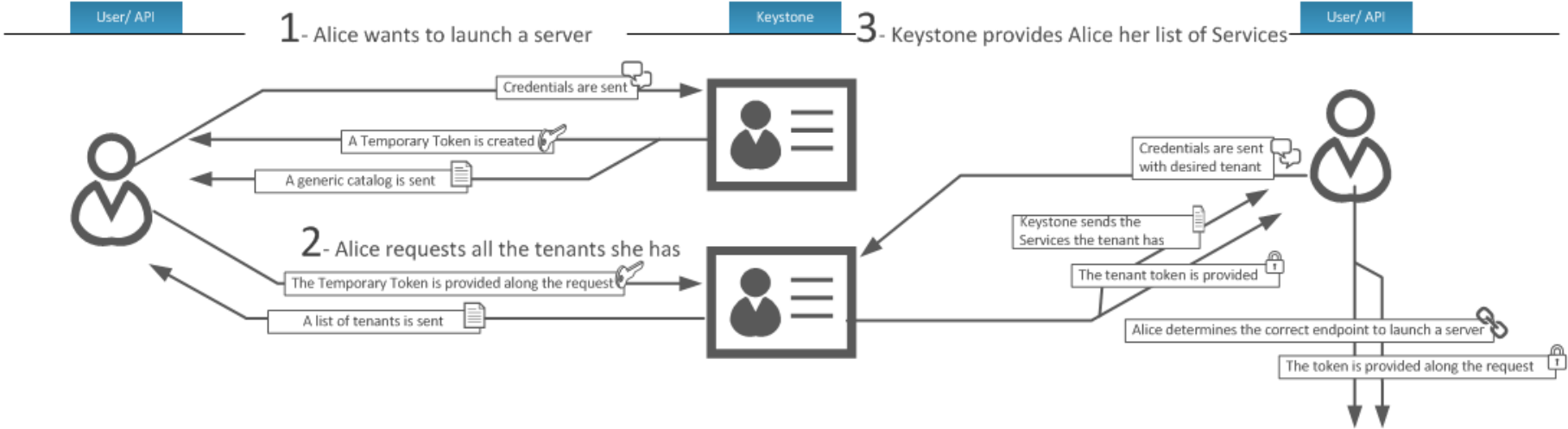

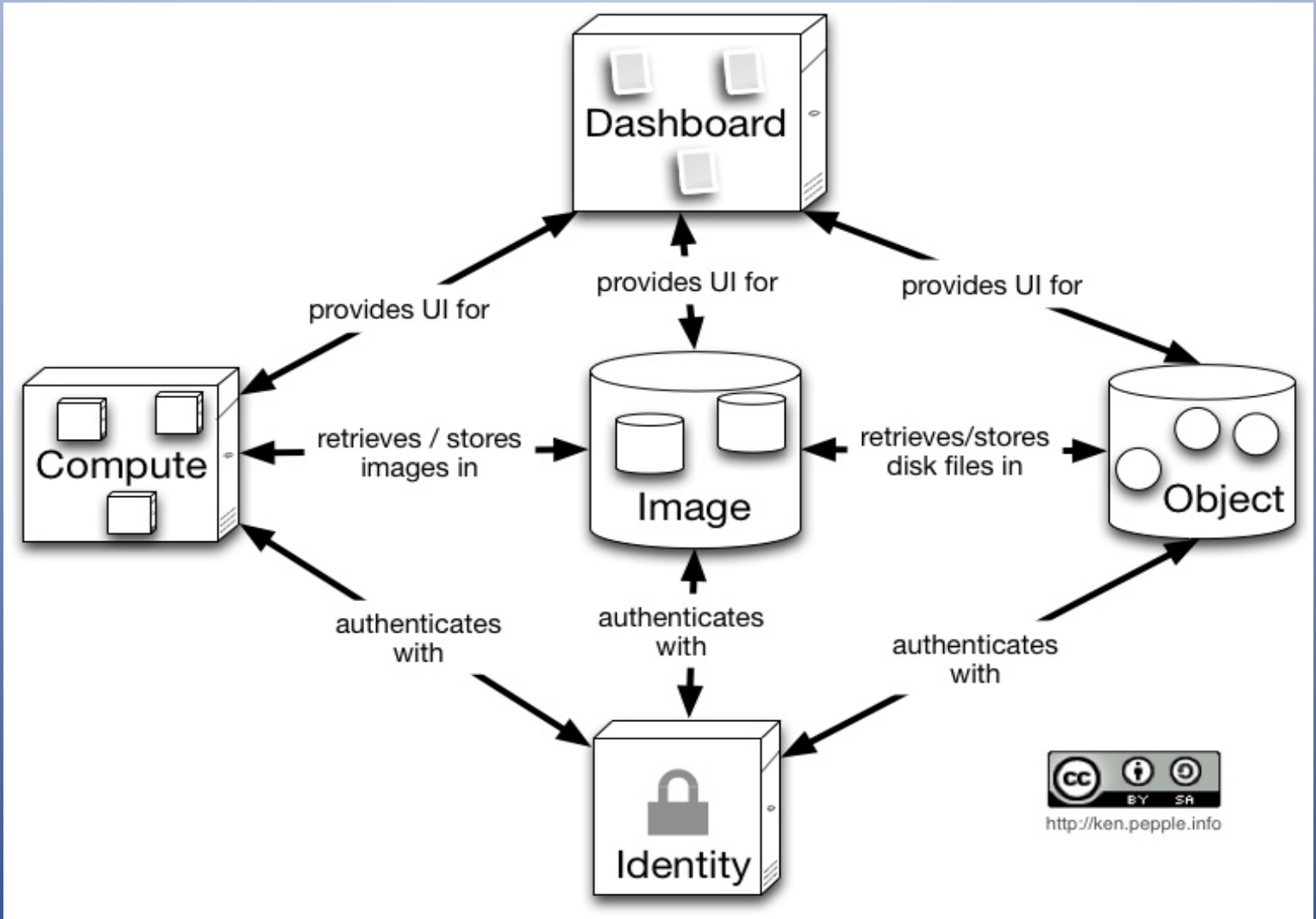

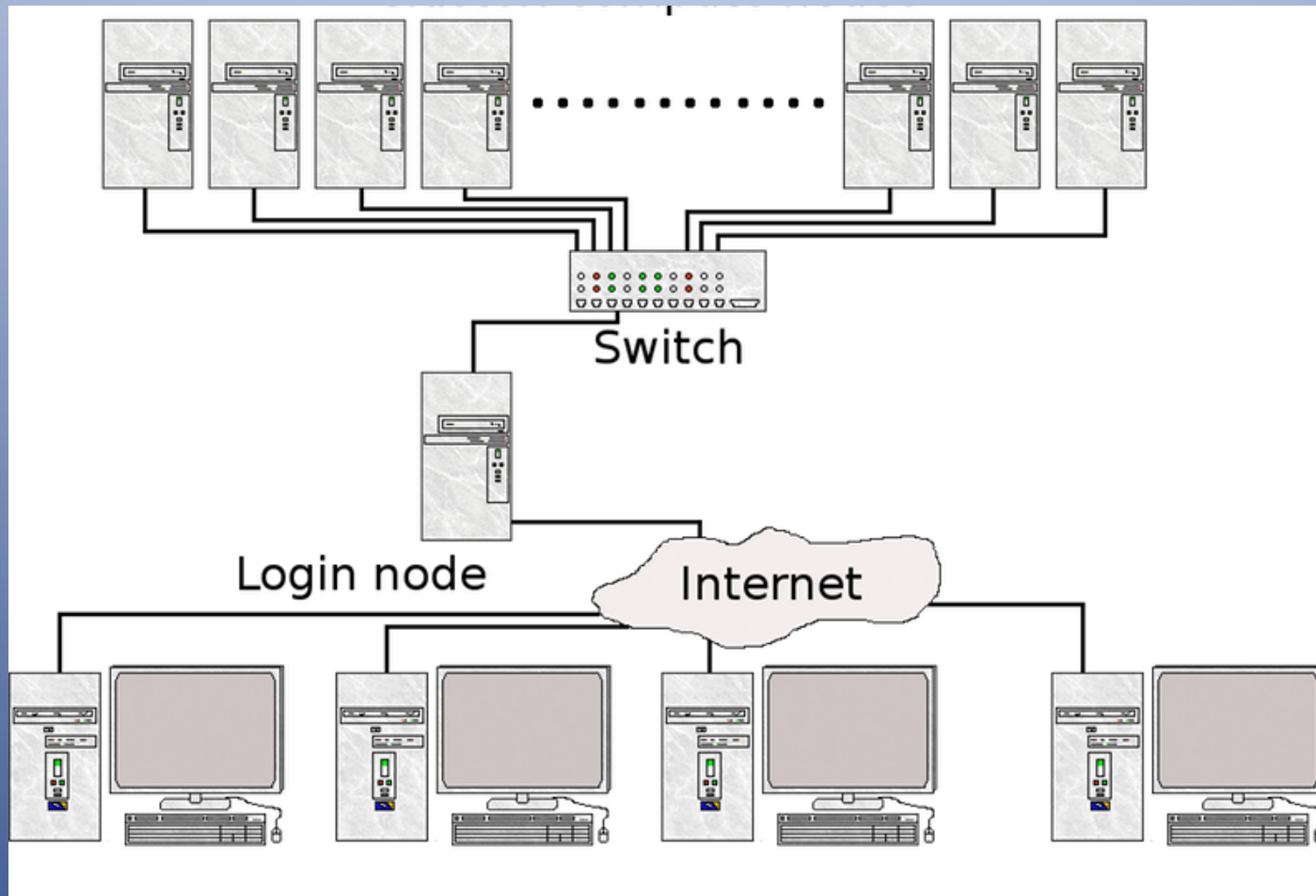

FIU

Engineering
& Computing

OPEN SCIENCE
OSDC
DATA CLOUD

unesp

QUESTIONS ?

FIU

Engineering
& Computing

